

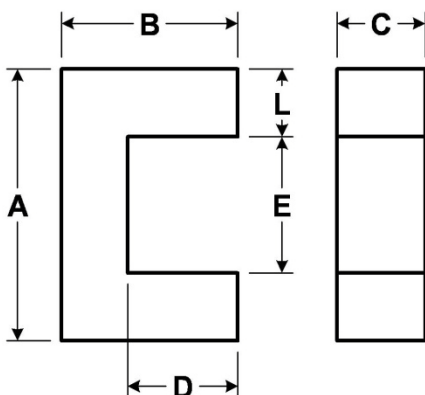

00K3112U060

110 Delta Drive
 Pittsburgh, PA 15238
 Phone: 412/696-1333
 Fax: 412/696-0333
 Email:magnetics@spang.com



Permeability (μ)	A_L (nH/T ²)
60	111 ± 8%

DIMENSIONS (mm)		±
A	31.24	0.57
B	11.18	0.26
C	12.07	0.38
D (min)	2.54	--
E (min)	14.22	--
L (nom)	8.26	--

Markings		
XXXXXX	00K3112U060	N/A
Lot Number	Part Number	Inductance Grade

Physical Characteristics				
A_e (mm ²) Cross Section	L_e (mm) Path Length	V_e (mm ³) Volume	Weight (grams)	Box Quantity (pieces)
101	65.6	6,620	19.5	672

Available Hardware

