

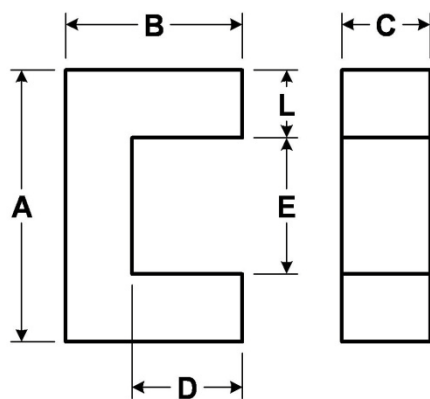

00K6527U026

110 Delta Drive
 Pittsburgh, PA 15238
 Phone: 412/696-1333
 Fax: 412/696-0333
 Email:magnetics@spang.com



Permeability (μ)	A_L (nH/T ²)
26	89 ± 8%

DIMENSIONS (mm)		±
A	65.15	1.35
B	32.51	0.30
C	27.0	0.41
D (min)	22.2	--
E (min)	44.22	--
L (nom)	10.02	--

Markings		
XXXXXX	00K6527U026	N/A
Lot Number	Part Number	Inductance Grade

Physical Characteristics				
A_e (mm ²) Cross Section	L_e (mm) Path Length	V_e (mm ³) Volume	Weight (grams)	Box Quantity (pieces)
270	219	59,100	154	54

Available Hardware

