

Specification for:

DP42318UG

110 Delta Drive
Pittsburgh, PA 15238
Phone: 412/696-1333
Fax: 412/696-0333
Email: magnetics@spang.com

DIMENSIONS

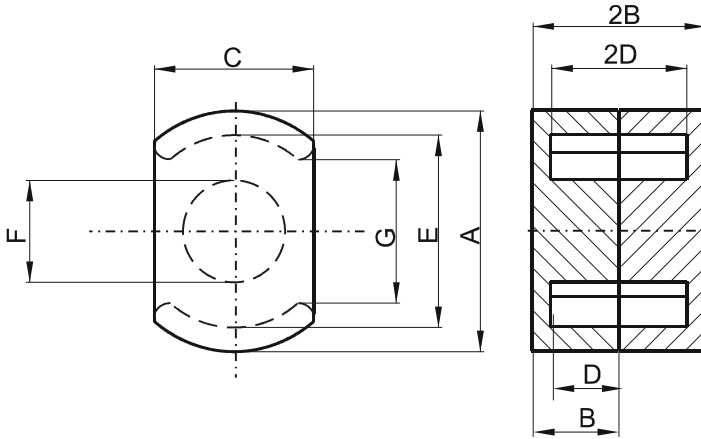

(mm)	Nominal:	Tol. min.:	Tol. max.:
A	22.86	-0.46	+ 0.46
B	9.0	-0.18	+ 0.18
2B	18.0	-0.36	+ 0.36
C	15.24	-0.25	+ 0.25
D	6.93 Min.		
2D	13.86 Min.		
E	17.93 Min.		
F	9.9 Max.		
G	13.21 Min.		
Eff. Parameters			
Ae mm²	Amin mm²	le mm	Ve mm³
58.0	40.7	39.9	2310

INDUCTANCE

AL value (nH)	Test conditions
Nom: 3160 Min.: 2370	10 kHz, < 0.5 mT, 25 °C

MARKING

P UG

CORE LOSSES

P _i max	Test conditions
113 mW/cm ³ (0.26 W/set)	100 kHz, 100 mT, 100 °C

NOTE

Spec. modifications	Previous	Revised
2005-06-22	Losses: General P material	Losses: Detail as indicated